



1300 240 298
info@directlifts.com.au
www.directlifts.com.au



CIBES LIFT

PROPOSAL DESCRIPTION FOR

Site reference

Model

Date

EOS ID. _____

Tender no. _____

Order no. _____

PLEASE FIND YOUR NEW LIFT SOLUTION

Thank you for your interest in Cibes Lift Group products. Safe, energy-efficient and durable, a platform lift by cibes is a smart and cost-efficient choice. It is our hope that this folder may assist you in your decision.



AIR

The lift is designed to have a small footprint and a maximum of space inside. Explore our lift solution for your site.

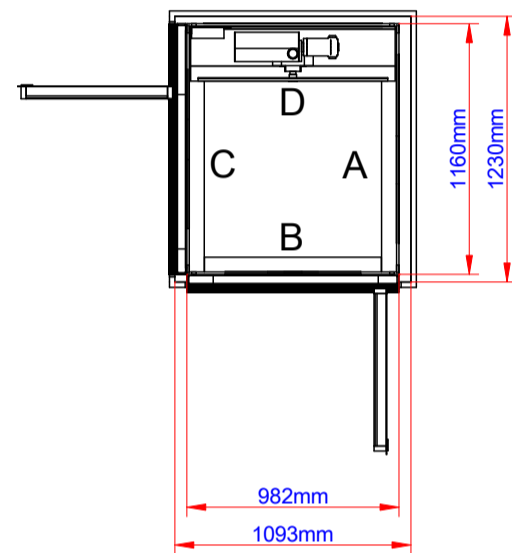

TECHNICAL INFORMATION

Travel information

Head room	2700 mm
Travel height	7871 mm
Landing 1	0 mm
Landing 2	2200 mm
Landing 3	4781 mm
Landing 4	7871 mm

Shaft Information

Lift shaft dimension(WXD)	1160 mm X 982 mm
Shaft cutout sizes	1229.5 mm X 1093 mm
Colour Shaft	FactoryWhite near RAL 9016 GU30 STD
Colour Corner Profiles	RAL 9016 GU 70 Traffic White
Glass colour	Clear glass std
Glass frame colour	RAL 9016 GU 70 Traffic White
Total number of doors	4
Doors on A side	0
Doors on B side	2
Doors on C side	2

YOUR PLATFORM LIFT HAS BEEN CUSTOMISED

Thank you for your interest in exploring our lift solution for your site. It is our hope that this customized lift information will assist you in your decision process. Please observe that all images and colour samples in this brochure are for inspirational purposes only. The illustrations have limitations for details, exact color, texture and dimensional tolerances. Please contact our sales representatives for final details. For critical colour matches, we advise you to use physical colour samples.



NOTE: The button labels are not according to your configuration

THE PLATFORM

The platform lift is a great way to add comfort, beauty and value to your building. The platform finishes are described in the below table:

Platform details

Safety bar	Natural anodized aluminum
Back wall	Metall: RAL 9016 GU 70 Traffic Whit
Front panel	Decolegno: black
Handrail	Natural anodized aluminum
Floor	Black altro pitch vm2020p (std)
Safety edges	RAL 9005 GU 5 Matte Jet Black

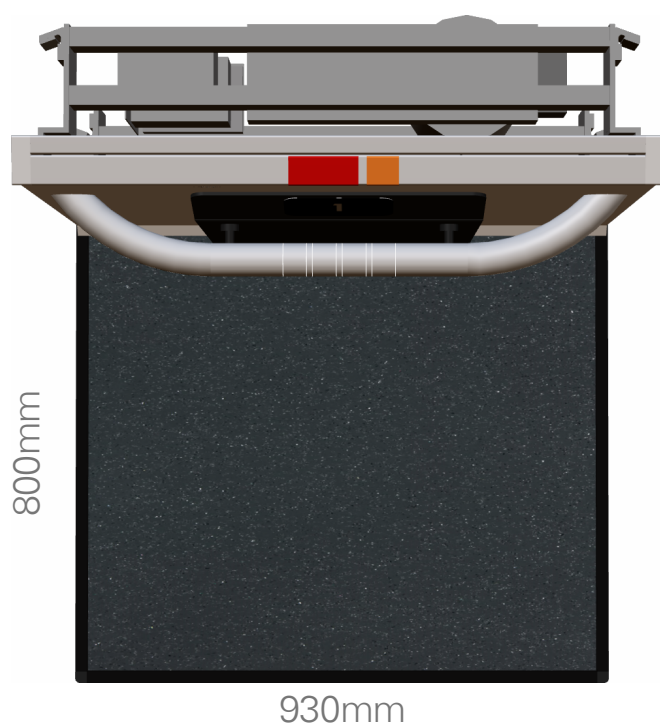
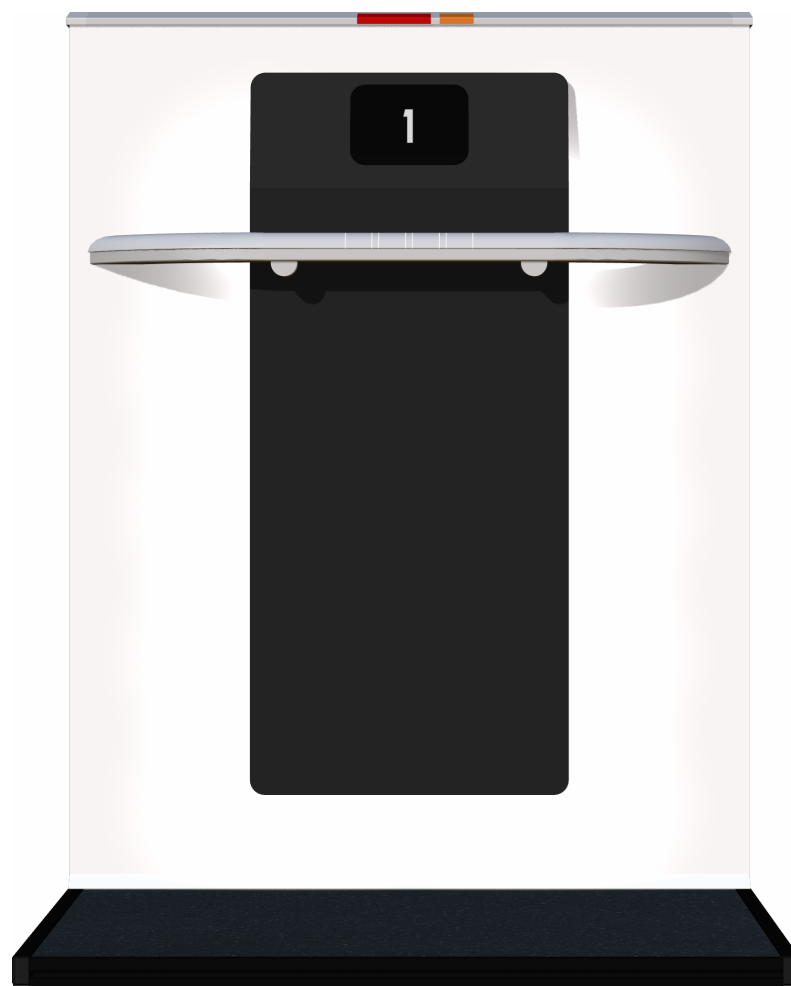

CALL BUTTON -
No locking solution

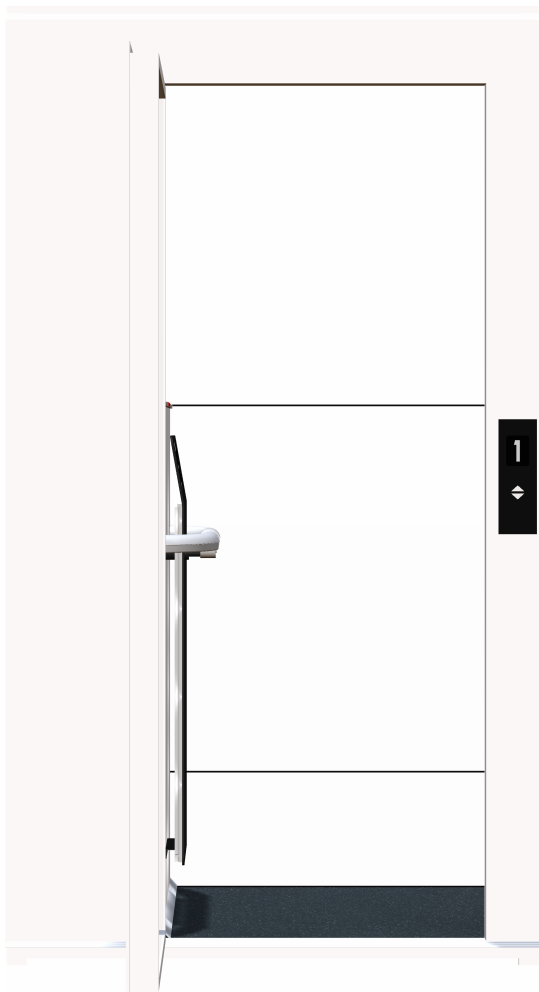
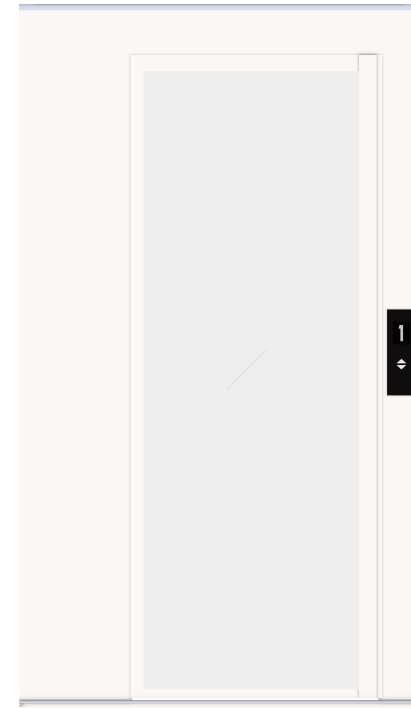
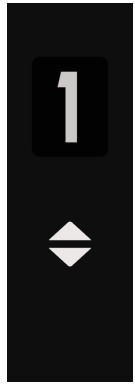

Landing 1	Door type AL6
Clear door opening size (WxH)	700mm X 1870mm
Door colour	RAL 9016 GU 30 Traffic White STD
Door opener	Door closer
Door placement	C
Glass	Standard clear glass
Call button	No locking solution
Level indicator	N/A

CALL BUTTON -
No locking solution

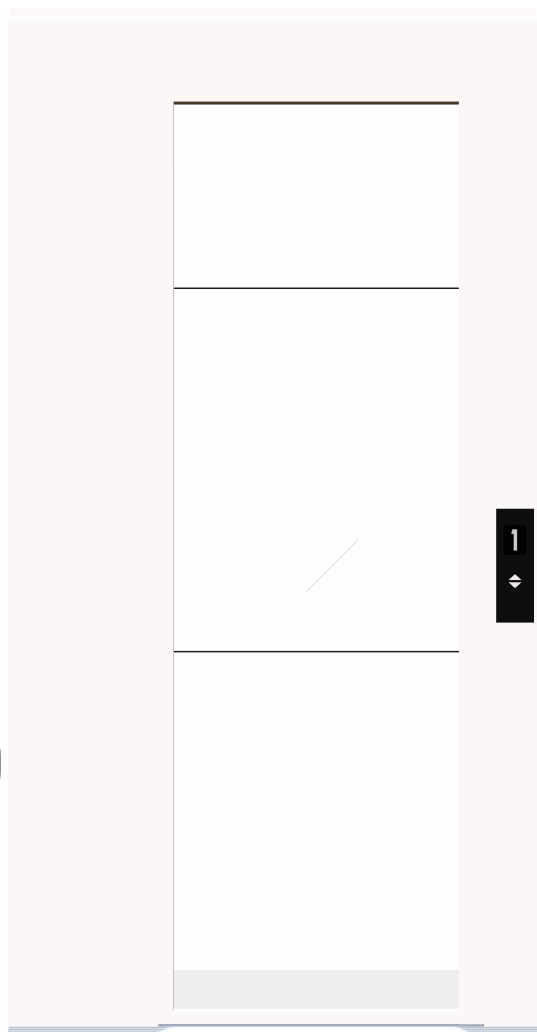
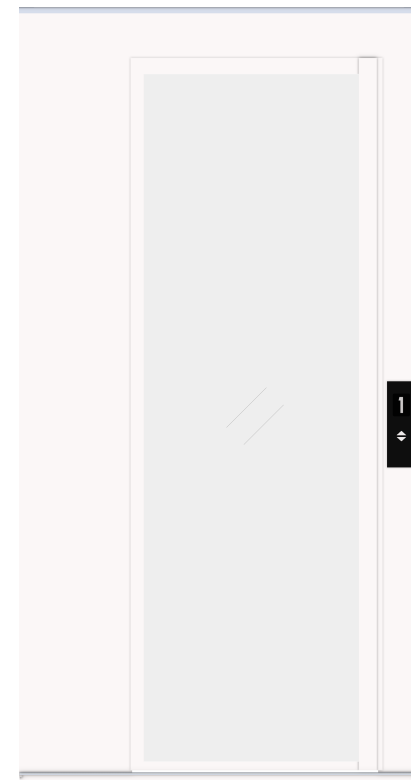
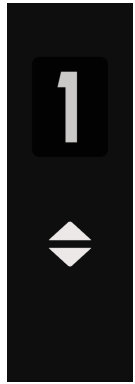

Landing 2	Door type AL6
Clear door opening size (WxH)	700mm X 2070mm
Door colour	RAL 9016 GU 30 Traffic White STD
Door opener	Door closer
Door placement	C
Glass	Standard clear glass
Call button	No locking solution
Level indicator	N/A

CALL BUTTON -
No locking solution

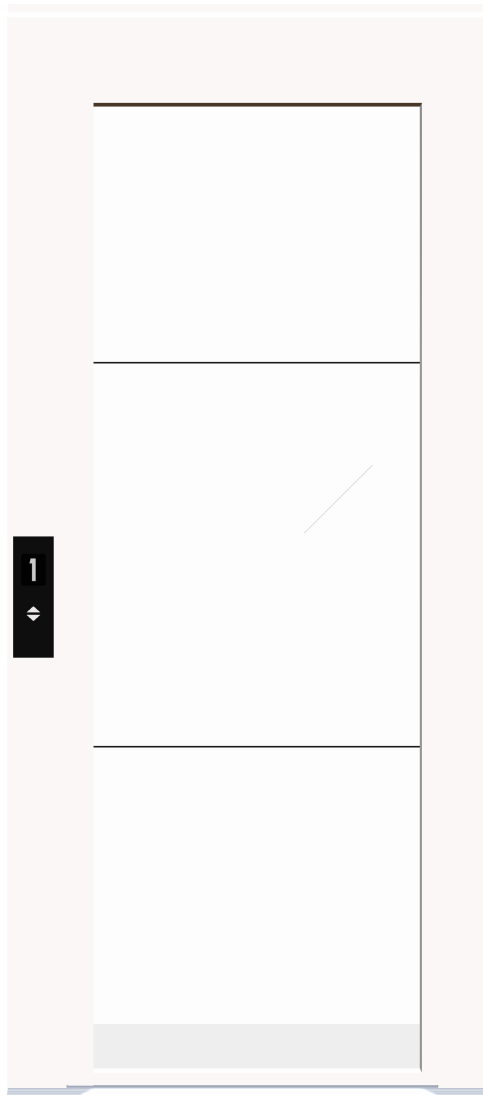
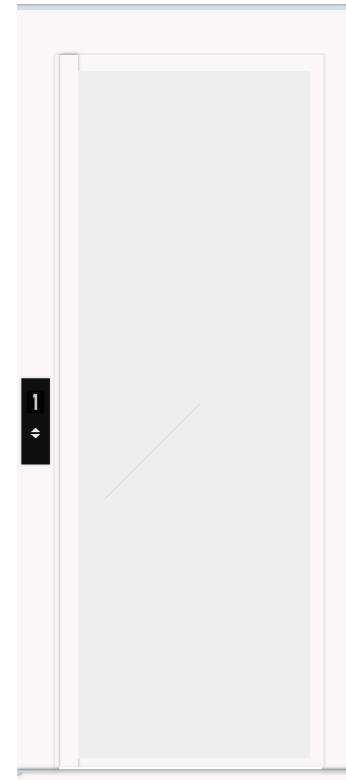
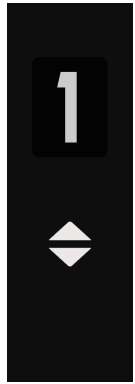

Landing 3	Door type AL6
Clear door opening size (WxH)	750mm X 2070mm
Door colour	RAL 9016 GU 30 Traffic White STD
Door opener	Door closer
Door placement	B
Glass	Standard clear glass
Call button	No locking solution
Level indicator	N/A

CALL BUTTON -
No locking solution

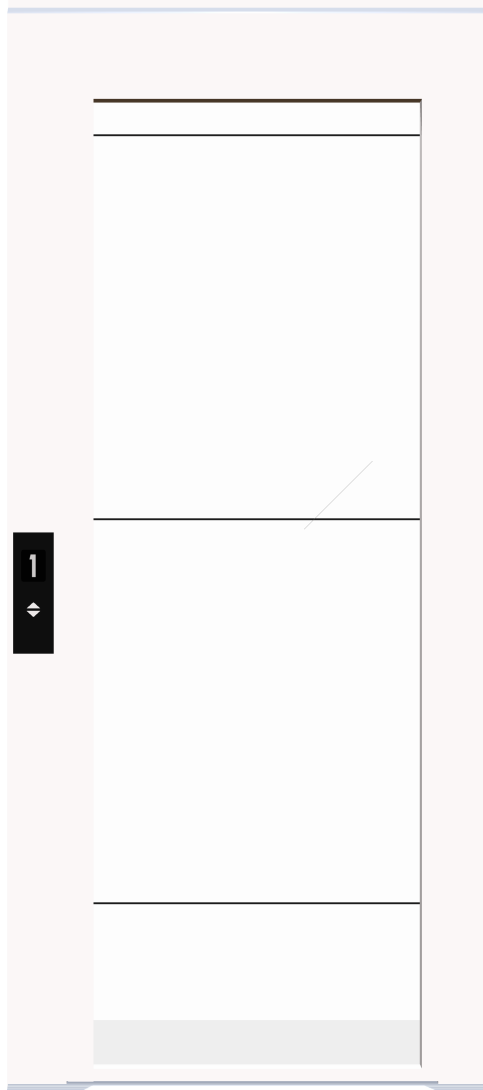
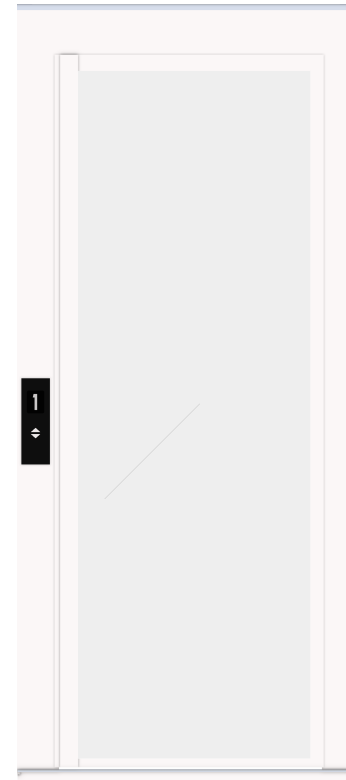
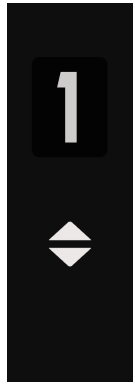

Landing 4	Door type AL6
Clear door opening size (WxH)	750mm X 2070mm
Door colour	RAL 9016 GU 30 Traffic White STD
Door opener	Door closer
Door placement	B
Glass	Standard clear glass
Call button	No locking solution
Level indicator	N/A

