

From: **Direct Lifts Australia**
 43 Telford St, Virginia, QLD, 4014, Australia
 +61 423 009 002
 info@directlifts.com.au

Object:

| | | | |
|--------------------------------|--------------------------------------------|------------------------------------------------------|--------|
| System | Screw-driven | Type of door | |
| Lifting weight | 400 kg | Aluminum with glass (standard) door 900x2000 (right) | 1 pcs. |
| Speed | 0.15 m/sec | Aluminum with glass (standard) Gate 900x1150 (right) | 1 pcs. |
| Platform dimensions | 1100 x 1400 mm | Opening the door | |
| Shaft dimensions | 1500 x 1460 mm | Automatic (external - on the door frame) | 2 pcs. |
| Platform lifting height | 2700 | | |
| Number of stops | 2 | | |
| Surface (paint color) | RAL 9005 (painted) | | |
| Lift type | Inside | | |
| Voltage | Power supply 220 V, 1 phase, 50 Hz, C25 | | |
| Frequency converter | Included | | |
| Keyboard language | English | | |

Additional equipment

| | |
|-------------------------------------------------------|---------|
| Automatic door opening (external - on the door frame) | 2 pcs. |
| Options for access restrictions - key | 1 pcs. |
| Anticorrosive painting | 1 pcs. |
| Telephone on the platform | 1 pcs. |
| Reinforced guide rails | 3890 mm |
| Shaft base frame in zinc | 1 pcs. |
| One touch operation | 1 pcs. |
| MC2 button | 2 pcs. |
| Packaging on the heated wood pallets | 1 pcs. |

Price

| | |
|--|--|
| | |
| | |

Keyboard

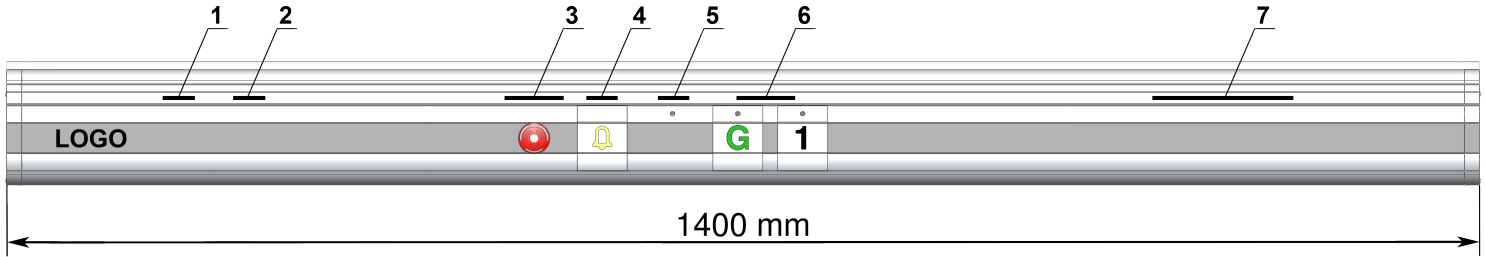

1. Mnf. Date: ****
2. Serial No. *****
3. **EMERGENCY STOP** Twist to release
4. **ALARM** Press for 10 sec.
5. OVERLOAD
6. PRESS AND HOLD
7. MAX. 4 PERS./ 400 KG

Logo on the control panel
Control panel strip color

Only Client logo
 Silver

Pit, Shaft and Platform dimensions

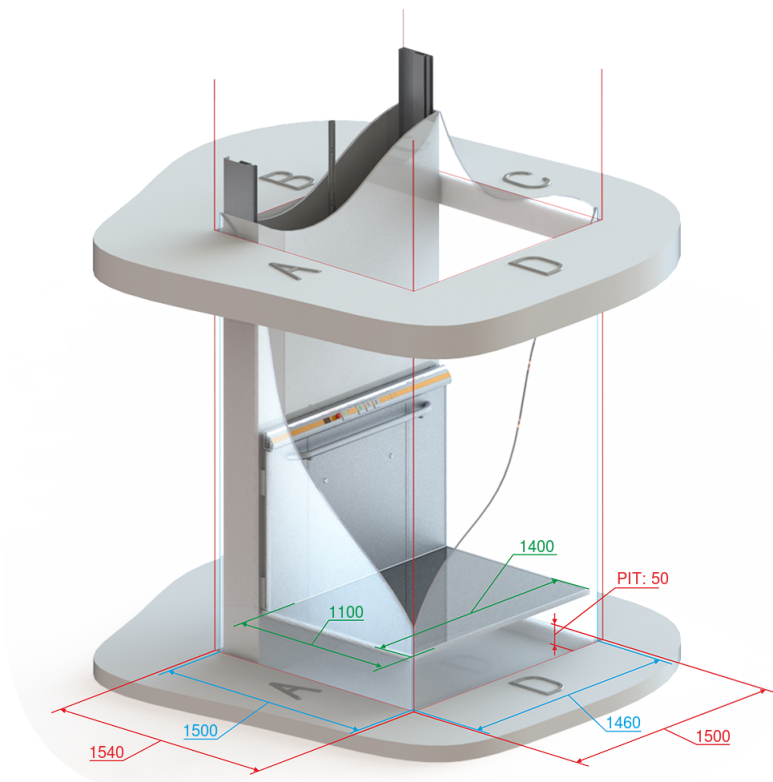

| Dimensions | |
|---------------------|----------------|
| Platform dimensions | 1100 x 1400 mm |
| Shaft dimensions | 1500 x 1460 mm |
| Pit dimensions | 1540 x 1500 mm |
| Pit | 50 mm |

Preliminary weights (gross)

| | |
|--------------------|--------|
| Guide rails pallet | 185 kg |
| Door pallet | 232 kg |
| Platform pallet | 503 kg |
| Total | 920 kg |

1

2

3

4

5

6

7

8

A

B

C

D

E

F

G

H

A

B

C

D

E

F

G

H

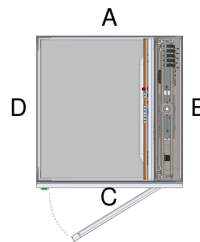
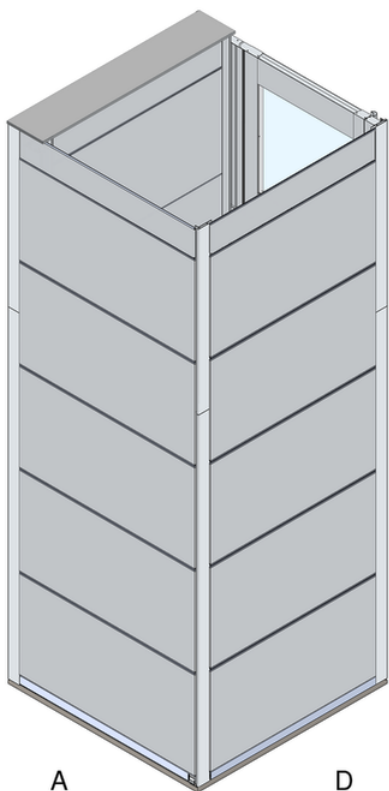

2 Floor
Floor numbering: 1
Platform lifting height: 2700
 mm
Doors C: 900x1150 mm

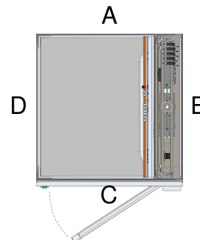

1 Floor
Evacuation floor
Floor numbering: G
Platform lifting height: 0 mm
Doors C: 900x2000 mm

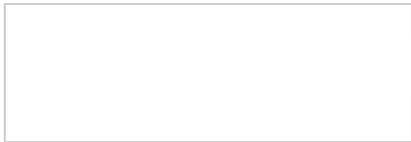

Principal drawing
 SB200 1100 x 1400 mm
 General 3D

1

2

3

4

5

6

7

1 2 3 4 5 6 7 8

A

G - Glass
S - Sandwich

Platform lift height: 3873 mm

A

B



A

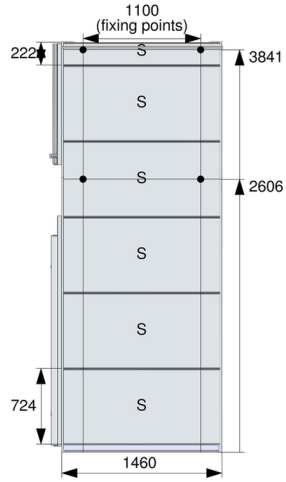

B

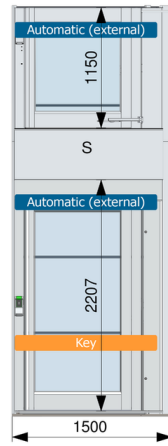

C

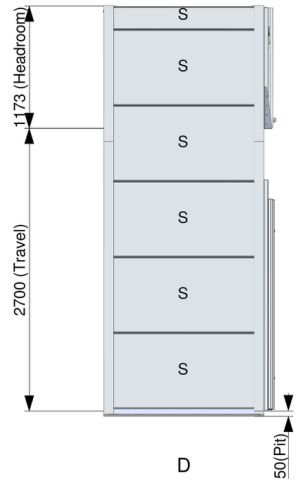

D

B

C

C

D

D

E

E

F

F

G

G

H

H

1 2 3 4 5 6 7 8



| | |
|-----------|---------------------------------------------------------|
| Serial no | Principal drawing SB200 1100 x 1400 mm General 2D |
| Order no | |
| Date | |